

RAINWATER RE-USE SYSTEMS COMMERCIAL - 0.5 - 2.0 L/SEC SUBMERSIBLE



FEATURES

The all new packaged Rain Water Reuse Pressure Pump Systems are ideal for commercial, urban and domestic applications.

BASEPLATE:

- > Easy to install, compact baseplate design, suitable for floor or wall mounting
- > Constructed from galvanised steel
- > Fibreglass anti-tamper / weather cover available as an option

PUMP:

- > 1 x Submersible multistage pump (loose supplied)
- > Stainless steel housing, impeller and shaft construction
- > Dual mechanical shaft seal with carbon/ceramic rotating seal faces

MANIFOLD:

- > 25mm pump discharge manifold (32mm on HYFLOW® 200 2.0 l/sec Range)
- > Pump isolation and non-return valves
- > Mains water back-up solenoid control valve
- > Mains water back-flow protection dual check valve
- > Stainless steel liquid filled pressure gauge
- > Pressure hydraulic accumulator tank
- > Pressure switch

RAINS MAINS CONTROLLER:

- > Standard - used for all 240v pumps up to 8amps
- > Premium - Used for all 415v & 240v pumps above 8amps



25 YEARS INDUSTRY EXPERIENCE

RANGE

STANDARD SYSTEM	COMPONENT CHOICES	PUMP MODEL				V / kW CURRENT
		HYFLOW75 0.5 l/sec 4.6A	HYFLOW100 0.5 l/sec 5.9A	HYFLOW150 1.0 l/sec 7.8A	HYFLOW200 2.0 l/sec 10.7A	
	+ SCREEN FILTER (MANUAL)	855034	855040	855046	*855052	SMALL BASE (UNLESS STATED)
	+ SCREEN FILTER (AUTO)	855035	855041	855047	*855053	
	+ SCREEN FILTER (MANUAL) CARTRIDGE FILTER & UV	+ 855036	+855042	*855048	*855054	
	+ SCREEN FILTER (AUTO) CARTRIDGE FILTER & UV	+855037	+855043	*855049	*855055	
PRODUCT CODES						

NOTES

1. Systems can be customised to suit any application
2. *These systems require the large base
3. +These systems include 1 cartridge filter

PERFORMANCE

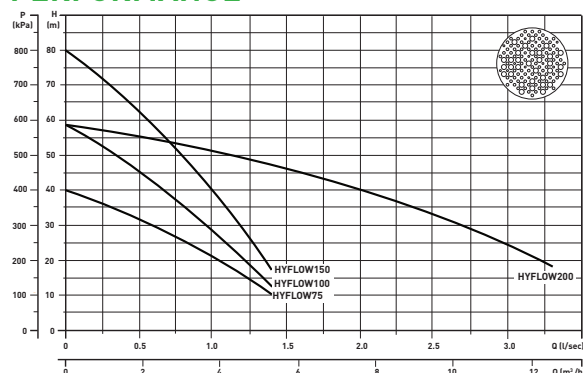

ADDED COMPONENTS



UNIQUE COVER DESIGN

Full cover removal or hinged access

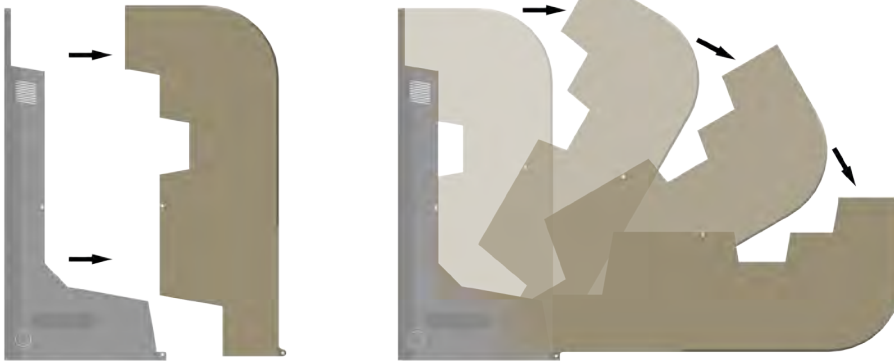

NOTES

1. Cover is optional
2. Standard Colorbond® Paperbark colour. Full Colorbond® colour range is available as a special order

DIMENSIONAL DRAWING

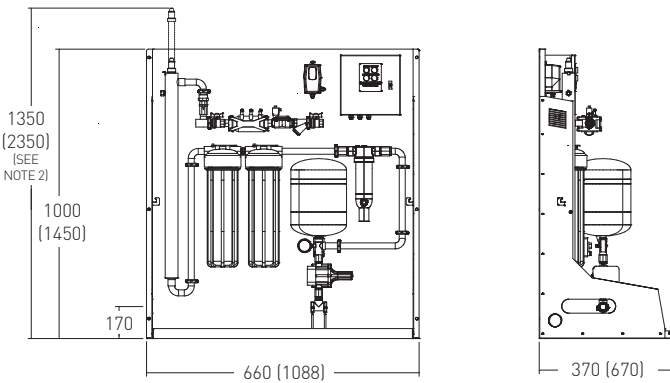

NOTES

1. Systems with multiple filters require large base dimensions (xxx)
2. For systems with UV Filtration allow stated clearance for maintenance
3. All dimensions are in mm and are approximate

TYPICAL ARRANGEMENT

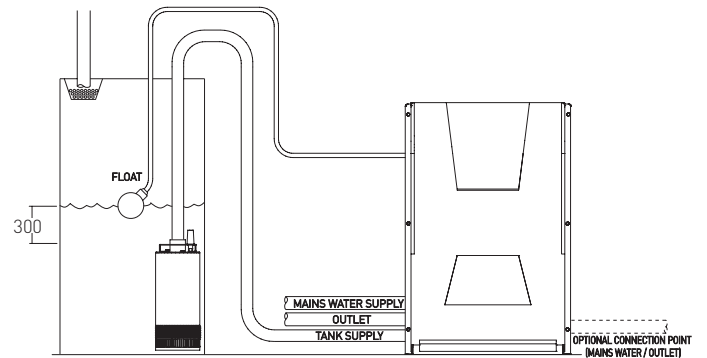

ADDITIONAL OPTIONS

MEDIUM & HIGH HAZARD BACKFLOW PROTECTION	CONSTANT PRESSURE VFD CONTROLLER	DUAL PUMPS	ANTI-TAMPER / WEATHER COVER	SUCTION STRAINER	WATER CHECK METER
					

