

# WATER PRESSURE SYSTEMS

## DUAL PUMPS - MAX FLOW: 22 L/SEC



### FEATURES

The Dual Pump Water Pressure System provides water boosting and is the perfect solution for commercial, high rise apartments, shopping complexes, hospitals, industry processes, municipal water supply and irrigation. Features Include:

#### BASE:

- > Common galvanised base plate and controller stand
- > Baseplate and lifting point designed to meet AS4100-1998 and AS1170.1-2002

#### MANIFOLD:

- > Stainless steel suction and discharge manifolds
- > Pump isolation and non return valves
- > 20mm test and drain valve
- > Stainless steel liquid filled pressure gauge
- > 60 litre pressure accumulator tank
- > Pressure Switch (DOL) / Pressure Sensing Transducer (VSD)

#### PUMPS:

- > In line vertical multistage pump with standard IEC motors and M.I.P (Maintenance in Place) capabilities
- > Cartridge mechanical shaft seal
- > Vibration isolation rubber mounts
- > AS/NZS 4020 potable water compliant

#### CONTROLLER:

- > Manufactured in accordance with the relevant standards: AS/NZS 3000:2007, AS1939 1990 and AS 3439.1 2002
- > Fixed Speed (DOL Start)
- > Constant Pressure VSD's (Variable Speed Drives)



## 30 YEARS INDUSTRY EXPERIENCE

### RANGE

PUMP MODEL	POWER (EACH PUMP)	DOL		VSD
		PRODUCT CODE (240v)	PRODUCT CODE (415v)	PRODUCT CODE (415v)
32-2	3.0 kW	870152	870153	870158
32-3	5.5 kW	-	870154	870159
32-4	7.5 kW	-	870155	870160
32-6	11 kW	-	870156	870161
32-8	15 kW	-	870157	870162

### NOTE

1. Systems can be customised to suit any application

### PERFORMANCE

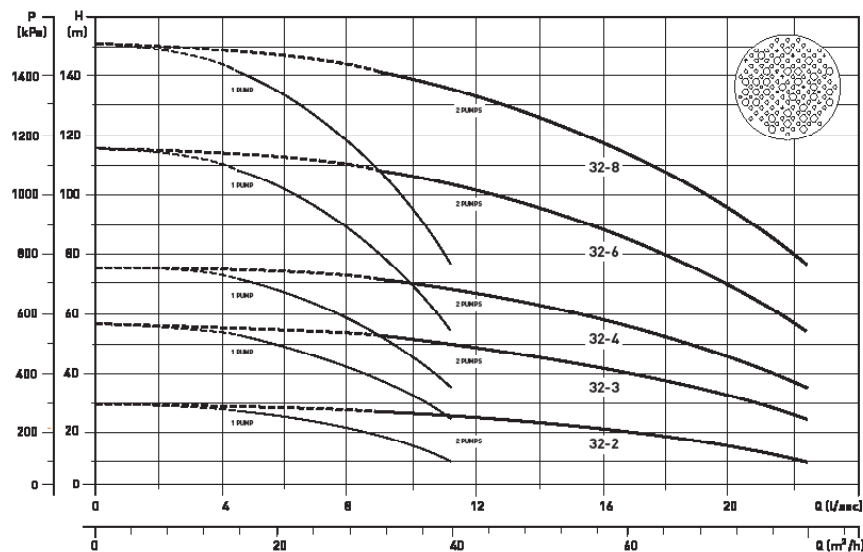

### NOTE

1. If a standby pump is required for redundancy, select additional duty pump accordingly

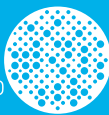

# WATER PRESSURE SYSTEMS

## DUAL PUMPS - MAX FLOW: 22 L/SEC

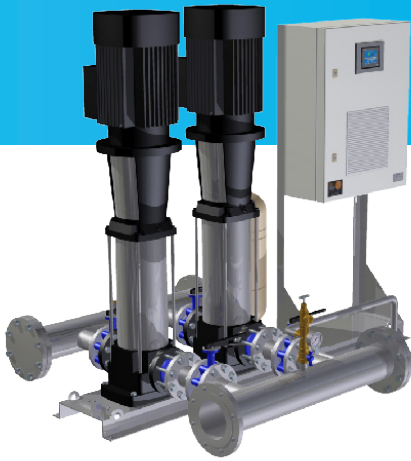

### DIMENSIONS

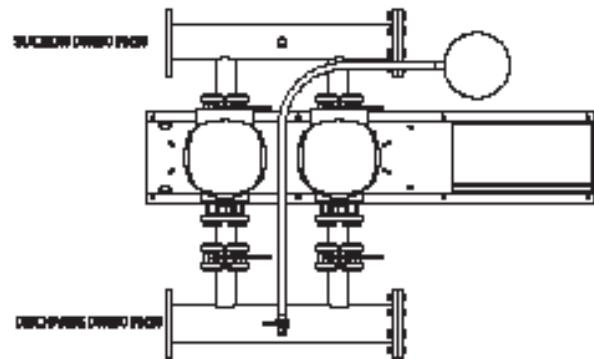
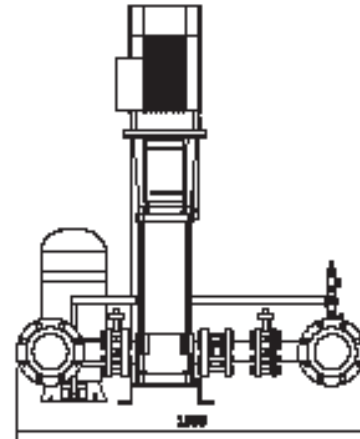
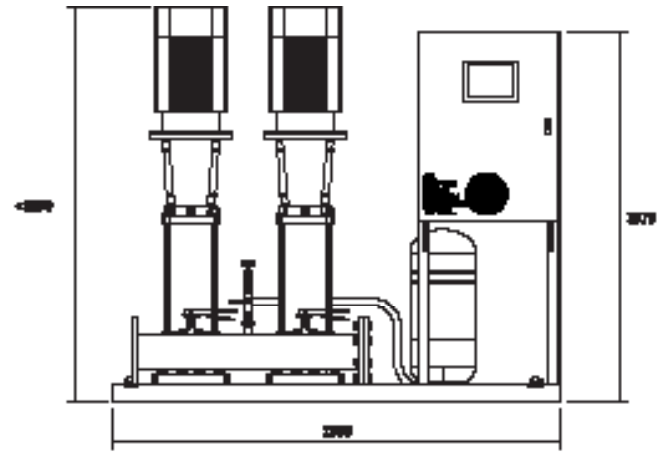

#### NOTE

1. All dimensions are in mm and are approximate



### ADDITIONAL OPTIONS

PRODUCT	DESCRIPTION	
	BREAK TANK	For mains water buffering
	SCREEN FILTRATION	For filtering impurities from the water supply
	PUMP ENCLOSURE	Protection from the elements as well as security against tampering
	TANK LEVEL CONTROL	System controllability
	LEVEL INDICATION	System communication
	REMOTE MONITORING MANAGEMENT (RMM)	Remote pump system management

APP ADVICE	FEATURE	BENEFIT
	M.I.P (Maintenance in Place) Heavy duty pumps with industry standard motors (not extended shaft design)	Pump mechanical seal and motor can be replaced on site without removing the pump from the pipework.
	Variable Speed Controller 1. Industry standard variable speed drives 2. Manufactured to Australian Electrical Standards	1. The equipment can be serviced and replaced without the limitation of proprietary expertise and parts. 2. Ensures that your equipment complies with the regulatory requirements of AS/NZS 3000

