

TRADEWASTE FOOD OIL INTERCEPTOR & PUMP STATION

FEATURES

The All Purpose Pumps combined Food Oil Interceptor and pump stations are ideal for all commercial food preparation facilities, cafés, restaurants and many industrial food processing plants. They are constructed in stainless steel, polyethylene or fibreglass for simple on-site installation.

SUBMERSIBLE PUMPS:

- > Refer to HYFLOW Submersible Index

NOTES

1. Fats, oils and grease (FOG) from all commercial food preparation facilities must be treated to satisfy the local water authority requirements.
2. Over-all depths or heights, drain locations and vent connections are all approved by the installer to accommodate the exact site conditions.



30 YEARS INDUSTRY EXPERIENCE

ABOVE GROUND

STAINLESS STEEL



- > Heavy duty 304 stainless steel construction with integral strengthening.
- > Multi-part access covers with lock down latches.
- > Inlet, outlet and vent spigot connections.
- > Designed in accordance with the Trade Waste Authority (VIC) requirements.

POLYETHYLENE



- > Lightweight polyethylene panel with internal honey-comb closed cell structure, constructed from UV stabilised polyethylene
- > Screwed access covers, capable of being removed by one person.
- > Inlet and vent spigot connections.
- > Outlet BSP pumpline connection
- > Removable screwed plug on outlet riser for easy removal of any blockages.
- > Designed in accordance with the Trade Waste Authority (VIC) requirements.

BELOW GROUND

POLYETHYLENE

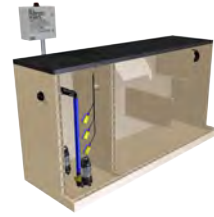

- > Lightweight sandwich panel with internal honey-comb closed cell structure, constructed from UV stabilised polyethylene
- > Multi-part air tight covers
- > Inlet, outlet and vent spigot connections.
- > Removable plug on outlet riser for easy removal of any blockages.
- > Designed in accordance with the Trade Waste Authority (VIC) requirements.



DIMENSIONS

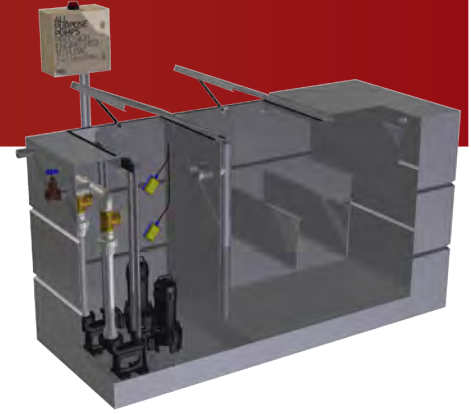
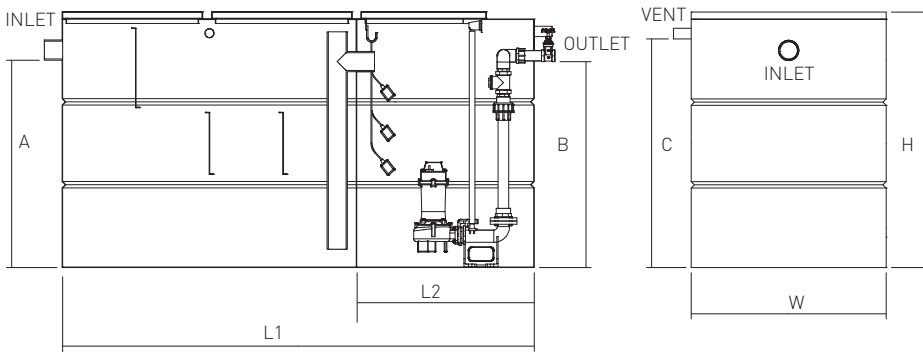

STAINLESS STEEL (ABOVE GROUND)

CAPACITY	L1	L2	W	H	A	B	C	INLET	OUTLET	VENT
100l	1430	650	360	540	435	360	440	50	40	40
250l	1550	650	600	800	550	475	710	50	40	40
400l	1850	650	600	900	650	575	810	100	50	50
600l	2000	800	800	950	700	625	850	100	50	50
1,100l	2300	800	1000	1065	810	735	965	100	50	50
1,500l	2850	800	1000	1065	810	735	965	100	50	50
2,000l	2660	1000	1100	1450	1175	1100	1350	100	50	50
3,000l	3000	1000	1300	1500	1200	1125	1350	100	80	80
4,000l	3500	1200	1500	1500	1250	1175	1350	100	80	80
5,000l	3500	1200	1500	1800	1550	1475	1650	100	80	80

POLYETHYLENE (ABOVE GROUND)

CAPACITY	L1	L2	W	H	A	B	C	INLET	OUTLET	VENT
100l	1500	650	510	595	420	370	430	50	40	40
250l	1700	650	750	950	650	575	850	50	40	40
400l	2000	650	750	950	650	575	850	100	50	50
600l	2150	800	900	1050	750	675	900	100	50	50
1,100l	2450	800	1100	1165	905	830	1065	100	50	50
1,500l	3050	800	1100	1165	905	830	1065	100	50	50
2,000l	3450	1000	1100	1400	1075	1000	1300	100	50	50
3,000l	4250	1000	1250	1400	1075	1000	1300	100	80	80
4,000l	4450	1200	1600	1400	1075	1000	1300	100	80	80
5,000l	4450	1200	1700	1500	1195	1120	1400	100	80	80

POLYETHYLENE (BELOW GROUND)

CAPACITY	L1	L2	W	H	A	B	C	INLET	OUTLET	VENT
100l	1580	650	510	600	485	410	500	50	40	40
250l	1700	650	750	820	595	520	720	50	40	40
400l	2050	650	750	1000	775	700	900	100	50	50
600l	2200	800	900	1100	875	800	1000	100	50	50
1,100l	2200	800	900	1200	1005	930	1100	100	50	50
1,500l	2300	800	900	1200	1005	930	1100	100	50	50
2,000l	3000	1000	900	1270	1095	1020	1170	100	50	50
3,000l	3900	1000	900	1500	1275	1200	1400	100	80	80
4,000l	4100	1200	900	1920	1655	1580	1920	100	80	80
5,000l	5700	1200	900	1580	1355	1280	1480	100	80	80

NOTES

1. External dimensions
2. All dimensions are in mm and are approximate
3. Also available as custom build in Fibreglass and 316SS

