

COMPONENTS HOSE KITS

FEATURES

These hose kits are ideal for connecting to a range of submersible pumps for discharging of water from building sites, flooded basements and more. The kits have polypropylene cam-lock connections to avoid corrosion and help resist impact damage.

REINFORCED HOSE KIT:

- > 20 Metres grey PVC suction / delivery hose, flexible and anti kink hose, male and female cam-lock connections and worm drive clamps
- > Male cam-lock pump connector
- > Poly BSP fittings to adapt to a range of pumps
- > Adaptor to enable vertical hose discharge or horizontal discharge connection for low level anti kink applications

LAYFLAT HOSE KIT:

- > 20 Metres blue PVC layflat hose
- > Male cam-lock pump connector
- > Poly BSP fittings to adapt to a range of pumps
- > Adaptor to enable vertical hose discharge or horizontal discharge connection for low level anti kink applications



25 YEARS INDUSTRY EXPERIENCE

RANGE

	HOSE DIAMETER	PRODUCT CODE	COMPACT PUMP HD32.025	CONTRACTOR PUMP		HV.50.04	HV.50.075
				HP25.04 (PUDDLE)	HP50.075		
REINFORCED HOSE	25mm	590556	✓	✓	✗	✗	✗
LAYFLAT HOSE	40mm	590557	✓	✓	✗	✗	✗
	50mm	590558	✗	✗	✓	✓	✓

NOTES

- Multiple hose kits can be connected to enable longer lengths
- Hose kits are 20m long to ensure ease of handling

TYPICAL ARRANGEMENT

REINFORCED HOSE KIT

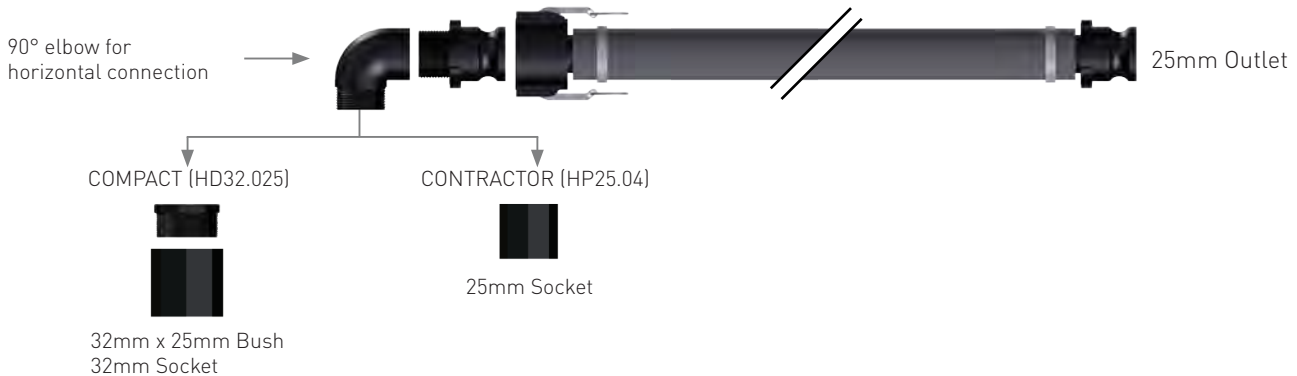

LAYFLAT HOSE KIT

