

RAINWATER RE-USE SYSTEMS COMMERCIAL - 2.0 LITRE PER SECOND



FEATURES

The all new packaged Rain Water Reuse Pressure Pump Systems are ideal for commercial, urban and domestic applications.

BASEPLATE:

- > Easy to install, compact baseplate design, suitable for floor or wall mounting
- > Constructed from galvanised steel
- > Anti-tamper / weather cover available as an option

PUMP:

- > Horizontal multistage centrifugal pump design.
- > TEFC electric motor
- > Stainless steel housing, impeller and shaft construction
- > Single spring mechanical shaft seal with carbon/ceramic rotating seal faces

MANIFOLD:

- > 32mm pump discharge manifold
- > Pump isolation and non-return valves
- > Mains water back-up solenoid control valve
- > Mains water back-flow protection dual check valve
- > Stainless steel liquid filled pressure gauge
- > Pressure hydraulic accumulator tank
- > Pressure switch

RAINS MAINS CONTROLLER:

(see page 258 for full specifications)

- > Standard - used for all 240v pumps up to 8amps
- > Premium - Used for all 415v & 240v pumps above 8amps



25 YEARS INDUSTRY EXPERIENCE

RANGE

STANDARD SYSTEM	COMPONENT CHOICES	PUMP MODEL	V / kW CURRENT	
				PHMS8-40
	+ SCREEN FILTER (MANUAL)		415V / 2.2KW 5.0A	LARGE BASE
	+ SCREEN FILTER (AUTO)		855028	
	+ *SCREEN FILTER (MANUAL) CARTRIDGE FILTER & UV		855029	
	+ *SCREEN FILTER (AUTO) CARTRIDGE FILTER & UV		855030	
			855031	
			PRODUCT CODES	

NOTE

1. Systems can be customised to suit any application

PERFORMANCE

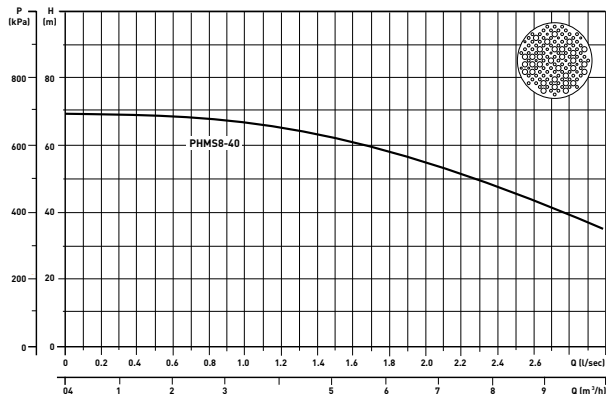

ADDED COMPONENTS

SCREEN FILTER (MANUAL)	SCREEN FILTER (AUTOMATIC)	FINE FILTRATION & UV
Refer to Page 222 for full specifications	Refer to Page 223 for full specifications	Refer to Page 218 for full specifications





UNIQUE COVER DESIGN

Full cover removal

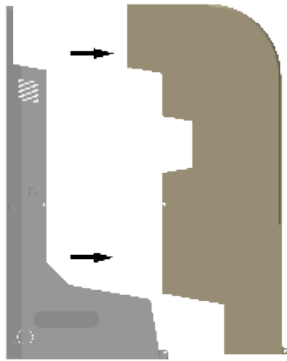

NOTES

1. Cover is optional
2. Available in galvanised steel/aluminium finish or powder coat (option)

DIMENSIONAL DRAWING

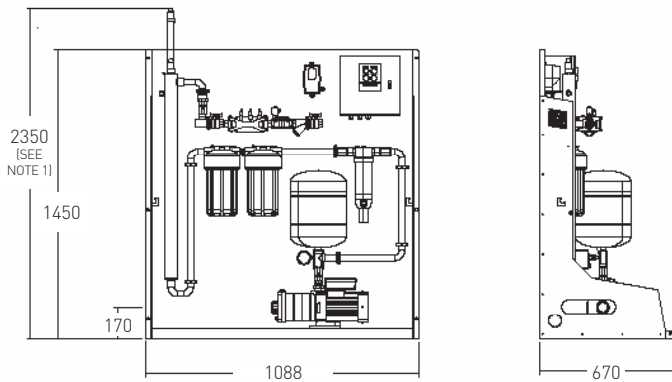



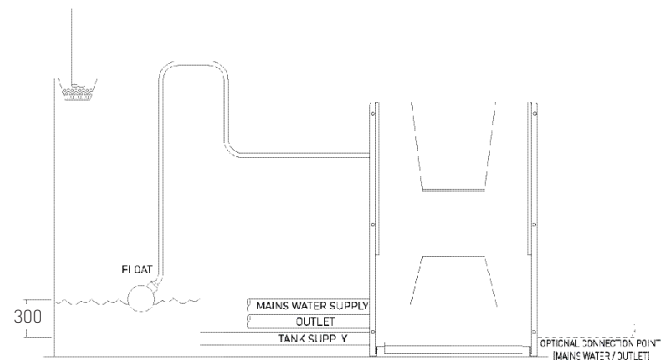



TYPICAL ARRANGEMENT

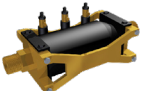

NOTES

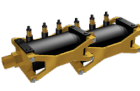
1. For systems with UV Filtration allow stated clearance for maintenance
2. All dimensions are in mm and are approximate

ADDITIONAL OPTIONS

MEDIUM & HIGH HAZARD BACKFLOW PROTECTION	CONSTANT PRESSURE VFD CONTROLLER	DUAL PUMPS	ANTI-TAMPER / WEATHER COVER	SUCTION STRAINER	WATER CHECK METER
					
Refer to page 275 for full specifications	Refer to page 254 for full specifications	Refer to page 202 for full specifications	Refer to page 244 for full specifications	Refer to page 231 for full specifications	Refer to page 275 for full specifications

